

# FX2N

This manual contains text, diagrams and explanations which will guide the reader in the correct installation and operation of the FX2N-4DA special function block and should be read and understood before attempting to install or use the unit.

Further information can be found in the FX PROGRAMMING MANUAL(II) and FX0N/FX1N/FX2N/FX2NC/FX3U/FX3UC SERIES HARDWARE MANUAL.

## Guidelines for the Safety of the User and Protection of the FX2N-4DA special function block.

This manual should be used by trained and competent personnel. The definition of such a person or persons is as follows:

- Any engineer using the product associated with this manual, should be of a competent nature, trained and qualified to the local and national standards. These engineers should be fully aware of all aspects of safety with regards to automated equipment.
- Any commissioning or service engineer must be of a competent nature, trained and qualified to the local and national standards.
- All operators of the completed equipment should be trained to use this product in a safe and coordinated manner in compliance to established safety practices.

**Note:** The term 'completed equipment' refers to a third party constructed device which contains or uses the product associated with this manual.

### Notes on the Symbols Used in this Manual

At various times throughout this manual certain symbols will be used to highlight points of information which are intended to ensure the users personal safety and protect the integrity of equipment.



- 1) Indicates that the identified danger **WILL** cause physical and property damage.



- 2) Indicates that the identified danger could **POSSIBLY** cause physical and property damage.

- Under no circumstances will Mitsubishi Electric be liable or responsible for any consequential damage that may arise as a result of the installation or use of this equipment.
- All examples and diagrams shown in this manual are intended only as an aid to understanding the text, not to guarantee operation. Mitsubishi Electric will accept no responsibility for the actual use of the product based on these illustrative examples.
- Owing to the very great variety in possible application for this equipment, you must satisfy yourself as to its suitability for your specific application.

---

---

## 1. INTRODUCTION

---

---

- The FX2N-4DA analog special function block has four analog output channels. The output channels take a digital value and output an equivalent analog signal. This is known as a D/A conversion. The FX2N-4DA has a maximum resolution of 12 bits.
- The selection of voltage or current based input/output is by user wiring. Analog ranges of -10 to 10V DC (resolution: 5mV), and/or 0 to 20mA (resolution: 20 $\mu$ A) maybe selected independently for each channel.
- The FX2N-4DA can connected to the FX0N/FX1N/FX2N/FX2NC/FX3U/FX3UC series Programmable Controllers (PLC).
- Data transfer between the FX2N-4DA and the main unit is completed buffer memory exchange. There are 32 buffer memories (each of 16 bits) in the FX2N-4DA.
- The FX2N-4DA occupies 8 I/O points on the FX2N expansion bus. The 8 I/O points can be allocated from either inputs or outputs. The FX2N-4DA draws 30mA from the 5V rail of the main unit or powered extension unit.

## 2. EXTERNAL DIMENSIONS AND PARTS

Dimensions: mm (inches)

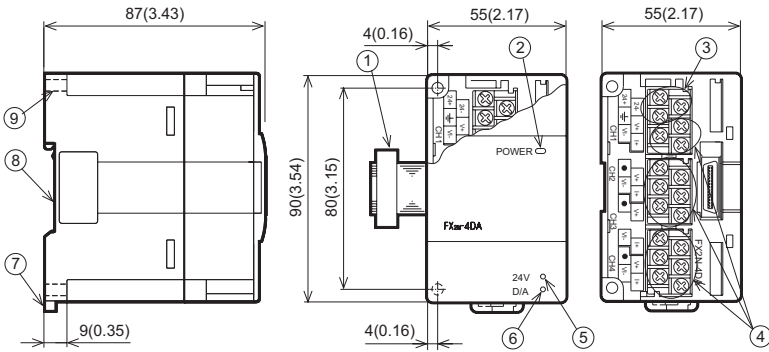

- Weight: Approx. 0.3 kg (0.66 lbs)
  - Accessory: Special block number label
- ① Extension cable
  - ② Power indicator lamp (LED)  
5 V power is supplied from the programmable controller to light this indicator lamp.
  - ③ Power supply terminals  
(Screw terminal: M3 (0.12))
  - ④ Analog output terminals  
(Screw terminals: M3 (0.12))
  - ⑤ 24V power indicator lamp (LED) 24V DC power is supplied to the terminals of the FX2N-4DA to light this indicator lamp.
  - ⑥ D/A conversion indicator lamp (LED)  
Flashes at a high speed if D/A conversion is performing without a problem.
  - ⑦ Hook for DIN rail
  - ⑧ Groove for DIN rail mounting  
(Width of DIN rail: 35 mm 1.38")
  - ⑨ Hole for direct mounting (2-φ4.5) (0.18)

### Handling of crimp-style terminal

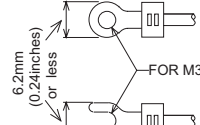

- Be sure to use the crimp-style terminals that satisfy the dimensional requirements shown in the left figure.
- Apply 0.5 to 0.8 N·m torque to tighten the terminals. Firmly tighten the terminals to prevent abnormal operation.

## 3. CONNECTION WITH PLC

The FX2N-4DA unit can be connected to the PLCs as follows. Restrictions apply to the maximum number of connectable units, depending on the DC24V/DC5V Power Supply capacities and the Main Unit/Special Function Unit types. For details, refer to the respective PLC manual.

FX2N/FX3U : The maximum connectable units is 8.

FX3UC\*1 : The maximum connectable units is 8.  
To connect the FX2N-4DA with the FX3UC main unit, FX2NC-CNV-IF or FX3UC-1PS-5V is required.

FX2NC : The maximum connectable units is 4.  
To connect the FX2N-4DA with the FX2NC main unit, FX2NC-CNV-IF is required.

FX1N : The maximum connectable units is 8.

FX0N : The maximum connectable units is 4.

\*1 Up to 7 units can be connected to an FX3UC-32MT-LT PLC.

## 4. WIRING

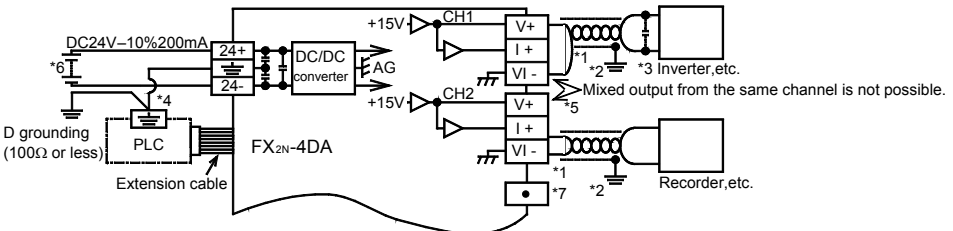

The terminal layout shown below may differ from the actual layout. For the correct terminal layout, refer to section 2 External Dimensions and Parts.



\*1: Use a twisted pair shielded cable for the analog output. This cable should be wired away from power lines or any other lines which could induce noise.

\*2: Apply 1-point grounding at the load side of the output cable (grounding: 100Ω or less).

\*3: If electrical noise or a voltage ripple exists at the output, connect a smoothing capacitor of 0.1 to 0.47μF, 25V.

\*4: Connect the  terminal on the FX2N-4DA with the  terminal on the main unit of the PLC.

\*5: Shorting the voltage output terminal or connecting the current output load to the voltage output terminal may damage the FX2N-4DA.

\*6: The 24V DC service power of the PLC can also be used.

\*7: Do not connect any unit to the unused terminal .



- 3) [BFM #5]: Data holding mode: While the programmable controller is in the STOP mode, the last output value in the RUN mode will be held. To reset the value to the offset value, write the hexadecimal value in BFM #5 as follows:



O = 0: Holds the output.  
O = 1: Resets to the offset value.

Example: H0011 ..... CH1 and CH2 = Offset value CH3 and CH4 = Output holding

In addition to the above functions, the buffer memories can adjust the I/O characteristics of the FX2N-4DA, and report the status of the FX2N-4DA to the PLC.

BFM	Description	
#8	Offset/gain setting command CH1, CH2 Initial value H0000	
#9	Offset/gain setting command CH3, CH4 Initial value H0000	
#10	Offset data CH1 <sup>*1</sup>	Unit: mV or mA Initial offset value: 0 Initial gain value: +5,000 } Output mode 0 <sup>*3</sup>
#11	Gain data CH1 <sup>*2</sup>	
#12	Offset data CH2 <sup>*1</sup>	
#13	Gain data CH2 <sup>*2</sup>	
#14	Offset data CH3 <sup>*1</sup>	
#15	Gain data CH3 <sup>*2</sup>	
#16	Offset data CH4 <sup>*1</sup>	
#17	Gain data CH4 <sup>*2</sup>	
#18, #19	Reserved	
W #20	Initialize. initial value = 0	
#21 E	I/O characteristics adjustment inhibit (Initial value 1)	
#22 - #28	Reserved	
#29	Error status	
#30	K3020 identification code	
#31	Reserved	

Buffer memories marked "W" can be written to using the TO instruction in the main unit. The status of BFM #0, #5, and #21, (marked E) will be written to EEPROM, therefore the set values will be retained even after turning off the power.

- \*1: Offset data:  
Actual analog output value when corresponding output data (BFM #1 through #4) is 0
- \*2: Gain data:  
Actual analog output value when corresponding output data (BFM #1 through #4) is +1,000
- \*3: When current output mode 1 (+4 mA to +20 mA) is set, the offset data will be automatically set to +4,000 and the gain data to +20,000. When the current output mode 2 (0 mA to +20 mA) is set, the offset data will be automatically set to 0 and the gain data to +20,000.

[BFM #8 and #9] Offset/gain setting command: Changes offset and gain values of channels CH1 through CH4 by writing 1 to the corresponding Hex digits of BFM #8 or #9. The current values will be valid until this command is output.

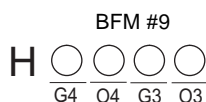
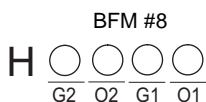

O = 0: No changes done.  
O = 1: Change data value.  
(Program example: see section 8.)

[BFM #10 through to #17] Offset/gain data: The offset and gain values are changed by writing new data to BFM #10 through to #17. The units of the data to be written is mV or  $\mu$ A. The data should be written and then BFM #8 and #9 set. Note that the data value will be rounded down to the nearest 5mV or 20mA.

- [BFM #20] Initialize: When K1 is written in BFM #20, all values will be initialized to the factory-default. (Note that the BFM #20 data will override the BFM #21 data.) This initialize function is convenient if you have an error in adjustment.
- [BFM #21] I/O characteristics adjustment inhibit: Setting BFM #21 to 2 inhibits the user from inadvertent adjustment of I/O characteristics. The adjustment inhibit function, once set, will be valid until the Permit command (BFM #21=1) is set. The initial value is 1 (Permit). The set value will be retained even after power-OFF.
- [BFM #29] Error status: When an error occurs, use the FROM command to read out the details of the error.

Bit	Name	Status when bit is set to "1" (turned on)	Status when bit is set to "0" (turned off)
b0	Error	Error if any of b1 through b4 is turned on	No error
b1	O/G error	Offset/gain data in EEPROM is abnormal or a data setting error occurs.	Offset/Gain data normal
b2	Power supply error	24V DC power failure	Power supplied normally
b3	Hardware error	Defective D/A converter or other hardware	Non-detective hardware
b10	Range error	The digital input or analog output value is out of the specified range.	The input or output value is in the specified range.
b12	G/O-Adjustment prohibit status	BFM #21 is not set to "1".	Adjustable status (BFM #21 = 1)

Bits b4 through to b9, b11, b13 through to b15 are not defined.

- [BFM #30] The identification code for a special function block is read using the FROM instruction. The identification code for the FX2N-4DA unit is K3020. The main unit can use this facility in the program to identify the special block before commencing any data transfers from and to the special function block.

## Note: BFM #'s marked E.

- Values of BFM #0, #5, and #21, (marked E) are stored in the EEPROM memory of the FX2N-4DA. BFM #10 to #17 are copied to EEPROM when the gain/offset setting command BFM #8, #9 is used. Also, BFM #20 causes the resetting of the EEPROM memory. The EEPROM has a life of about 10,000 cycles (changes), so do not use programs which frequently change these BFMs.
- A mode change of BFM #0 automatically involves a change of the corresponding offset and gain values. Because of the time needed to write the new values to the internal EEPROM memory, a delay of 3 s is required between instructions changing BFM #0 and instructions writing to the corresponding BFM #10 through BFM #17. Therefore, a delay timer should be used before writing to BFM #10 through #17.

## 7. OPERATION AND PROGRAM EXAMPLES

If the factory-default I/O characteristics are not changed and the status information is not used, you can operate the FX2N-4DA using the following simple program. For the FROM and TO instructions, refer to the FX Programming Manual (II).

- CH1 and CH2: Voltage output mode (-10 V to +10 V)
- CH3: Current output mode (+4 mA to +20 mA)
- CH4: Current output mode (0 mA to +20 mA)

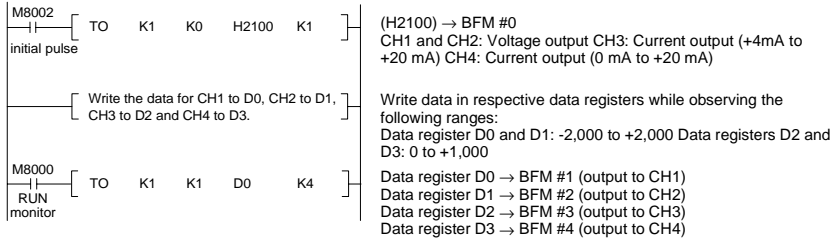

### Operation procedure

- 1) Turn OFF the power of the PLC, and then connect the FX2N-4DA. After that, wire the I/O lines of the FX2N-4DA.
- 2) Set the PLC to STOP, and turn on the power. Write the above program then switch the PLC to RUN.
- 3) Analog values will be sent from D0 (BFM #1), D1 (BFM #2), D2 (BFM #3), and D3 (BFM #4) to the respective output channels of the FX2N-4DA. When the PLC is in STOP, the analog values set before stopping the PLC will remain output. (The output will be held.)
- 4) When the PLC is in STOP, the offset values can also be output. For a detailed description, refer to Section 6, 3).

## 8. CAUTION REGARDING OPERATION

- 1) Check whether the output wiring and/or expansion cables are properly connected on the FX2N-4DA analog special function block.
- 2) Check that the PLC system configuration rules have not been broken, i.e. the number of blocks, and the total system I/O are within the specified range.
- 3) Ensure that the correct output mode has been selected for the application.
- 4) Check that there is no power overload on either the 5V or 24V power source, remember the loading on the main unit or a powered extension unit varies according to the number of extension blocks or special function blocks connected.
- 5) Put the main processing unit into RUN.
- 6) After turning ON or OFF the 24V DC power for analog signals, the analog output may fluctuate for approximately 1 second. This is due to time delays in the power supply from the main unit or differences in start time. For this reason, be sure to take preventive measures so that this output fluctuation will not affect the external units.

### [Example of preventive measure]

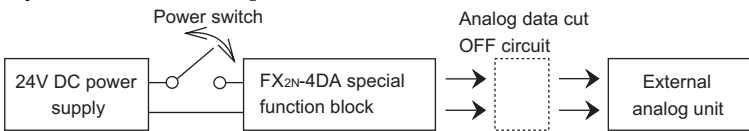

## 9. ADJUSTMENT OF the I/O CHARACTERISTICS

### 9.1 I/O characteristics

The standard characteristics (factory default) are shown by the solid lines in the figure below. These characteristics can be adjusted according to the conditions of the user's system.

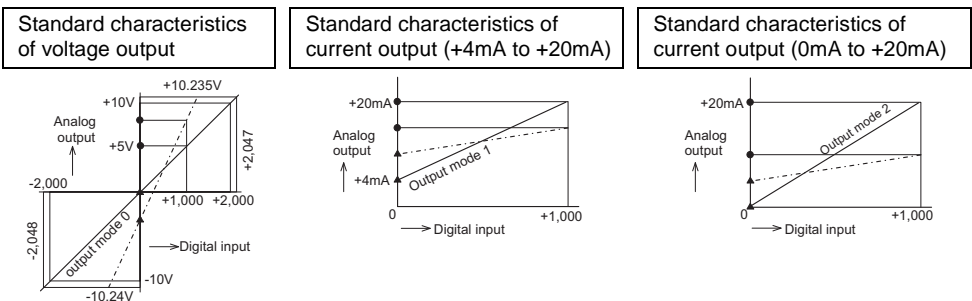

● ... Gain value : Analog output value when the digital input is +1,000

▲ ... Offset value : Analog output value when the digital input is 0

Offset and gain can be set independently or together. Reasonable offset ranges are -5V to +5V or -20mA to +20mA, and gainvalue-offset value=1V to 15V or 4mA to 32mA.

Gain and offset can be adjusted from software in the main unit.

When the slope of the I/O characteristic line is steep:

Slight changes to the digital input will greatly increase or reduce the analog output.

When the slope of the I/O characteristic line is gentle:

Slight changes to the digital input will not always change the analog output.

Note that the resolution (minimum possible change of analog output) of the FX2N-4DA is fixed.

## 9.2 Adjustment of I/O Characteristics

An example program for adjustment is shown below. The example shows that for channel CH2 of FX2N-4DA block No.1, the offset value is changed to 7 mA, and the gain value to 20 mA. Note that for CH1, CH3, and CH4, the standard voltage output characteristics are set.

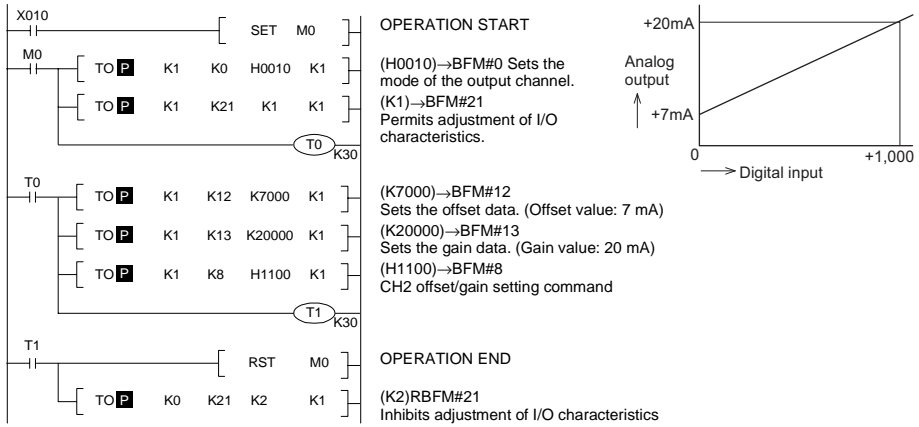

## 10.TROUBLESHOOTING

If the FX2N-4DA does not operate properly, check the following items

- 1) Check the external wiring. Refer to section 4 of this manual.
- 2) Check status of the POWER indicator lamp (LED) of the FX2N-4DA.
  - On : The extension cable is properly connected.
  - Off or flash : Check connection of extension cable. Also check the 5 V power supply capacity.
- 3) Check status of the 24 V power indicator lamp (LED) of the FX2N-4DA.
  - On : 24 VDC is supplied.
  - Off : Supply 24 VDC (+10%) to the FX2N-4DA.
- 4) Check the status of the D/A conversion indicator lamp (LED) of the FX2N-4DA.
  - Flash : D/A conversion is normal.
  - On or off : The ambient conditions are not suitable for the FX2N-4DA, or the FX2N-4DA is defective.
- 5) Check that the external load resistance connected to each analog output terminal does not exceed the capacity of the FX2N-4DA drive (voltage output: 2kΩ to 1 MΩ / current output: 500Ω).
- 6) Check the output voltage or current value using a voltmeter or ammeter, and confirm that the output meets the I/O characteristics. If the output does not meet the I/O characteristics, adjust the offset and gain again. Refer to section 9.

### Note

To test the withstand voltage of the FX2N-4DA, connect all the terminals to the grounding terminal.

This manual confers no industrial property rights or any rights of any other kind, nor does it confer any patent licenses. Mitsubishi Electric Corporation cannot be held responsible for any problems involving industrial property rights which may occur as a result of using the contents noted in this manual.

Manual number : JY992D65901

Manual revision : D

Date : September 2007

 **MITSUBISHI ELECTRIC CORPORATION**

HEAD OFFICE : TOKYO BUILDING, 2-7-3 MARUNOUCHI, CHIYODA-KU, TOKYO 100-8310, JAPAN  
HIMEJI WORKS : 840, CHIYODA CHO, HIMEJI, JAPAN



# FX<sub>2N</sub>

## FX<sub>2N</sub>-4DA SPECIAL FUNCTION BLOCK

### USER'S GUIDE

JY992D65901D

This manual contains text, diagrams and explanations which will guide the reader in the correct installation and operation of the FX<sub>2N</sub>-4DA special function block and should be read and understood before attempting to install or use the unit.

Further information can be found in the FX PROGRAMMING MANUAL(II) and FX<sub>0N</sub>/FX<sub>1N</sub>/FX<sub>2N</sub>/FX<sub>2NC</sub>/FX<sub>3U</sub>/FX<sub>3UC</sub> SERIES HARDWARE MANUAL.

### Guidelines for the Safety of the User and Protection of the FX<sub>2N</sub>-4DA special function block.

This manual should be used by trained and competent personnel. The definition of such a person or persons is as follows:

- Any engineer using the product associated with this manual, should be of a competent nature, trained and qualified to the local and national standards. These engineers should be fully aware of all aspects of safety with regards to automated equipment.
- Any commissioning or service engineer must be of a competent nature, trained and qualified to the local and national standards.
- All operators of the completed equipment should be trained to use this product in a safe and coordinated manner in compliance to established safety practices.

**Note:** The term 'completed equipment' refers to a third party constructed device which contains or uses the product associated with this manual.

### Notes on the Symbols Used in this Manual

At various times throughout this manual certain symbols will be used to highlight points of information which are intended to ensure the users personal safety and protect the integrity of equipment.



- Indicates that the identified danger **WILL** cause physical and property damage.



- Indicates that the identified danger could **POSSIBLY** cause physical and property damage.

- Under no circumstances will Mitsubishi Electric be liable or responsible for any consequential damage that may arise as a result of the installation or use of this equipment.
- All examples and diagrams shown in this manual are intended only as an aid to understanding the text, not to guarantee operation. Mitsubishi Electric will accept no responsibility for the actual use of the product based on these illustrative examples.
- Owing to the very great variety in possible application for this equipment, you must satisfy yourself as to its suitability for your specific application.

## 1. INTRODUCTION

- The FX<sub>2N</sub>-4DA analog special function block has four analog output channels. The output channels take a digital value and output an equivalent analog signal. This is known as a D/A conversion. The FX<sub>2N</sub>-4DA has a maximum resolution of 12 bits.
- The selection of voltage or current based input/output is by user wiring. Analog ranges of -10 to 10V DC (resolution: 5mV), and/or 0 to 20mA (resolution: 20μA) maybe selected independently for each channel.
- The FX<sub>2N</sub>-4DA can connected to the FX<sub>0N</sub>/FX<sub>1N</sub>/FX<sub>2N</sub>/FX<sub>2NC</sub>/FX<sub>3U</sub>/FX<sub>3UC</sub> series Programmable Controllers (PLC).
- Data transfer between the FX<sub>2N</sub>-4DA and the main unit is completed buffer memory exchange. There are 32 buffer memories (each of 16 bits) in the FX<sub>2N</sub>-4DA.
- The FX<sub>2N</sub>-4DA occupies 8 I/O points on the FX<sub>2N</sub> expansion bus. The 8 I/O points can be allocated from either inputs or outputs. The FX<sub>2N</sub>-4DA draws 30mA from the 5V rail of the main unit or powered extension unit.

## 2. EXTERNAL DIMENSIONS AND PARTS

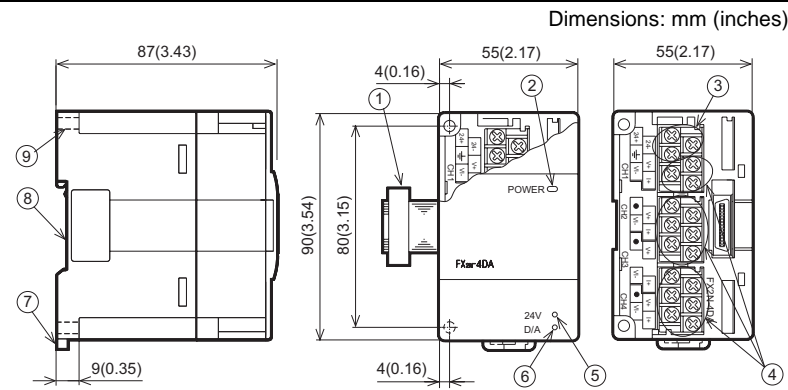

- Weight: Approx. 0.3 kg (0.66 lbs)
- Accessory: Special block number label

### Handling of crimp-style terminal

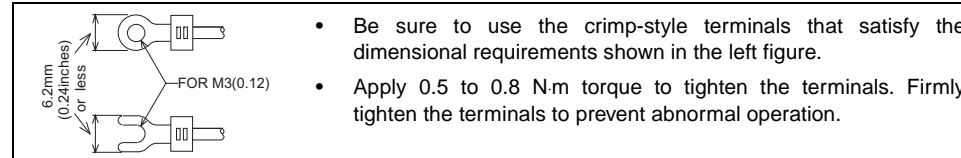

## 3. CONNECTION WITH PLC

The FX<sub>2N</sub>-4DA unit can be connected to the PLCs as follows. Restrictions apply to the maximum number of connectable units, depending on the DC24V/DC5V Power Supply capacities and the Main Unit/Special Function Unit types. For details, refer to the respective PLC manual.

- FX<sub>2N</sub>/FX<sub>3U</sub> : The maximum connectable units is 8.
- FX<sub>3UC</sub>\*1 : The maximum connectable units is 8. To connect the FX<sub>2N</sub>-4AD with the FX<sub>3UC</sub> main unit, FX<sub>2NC</sub>-CNV-IF or FX<sub>3UC</sub>-1PS-5V is required.
- FX<sub>2NC</sub> : The maximum connectable units is 4. To connect the FX<sub>2N</sub>-4DA with the FX<sub>2NC</sub> main unit, FX<sub>2NC</sub>-CNV-IF is required.
- FX<sub>1N</sub> : The maximum connectable units is 8.
- FX<sub>0N</sub> : The maximum connectable units is 4.

\*1 Up to 7 units can be connected to an FX<sub>3UC</sub>-32MT-LT PLC.

## 4. WIRING

The terminal layout shown below may differ from the actual layout. For the correct terminal layout, refer to section 2 External Dimensions and Parts.

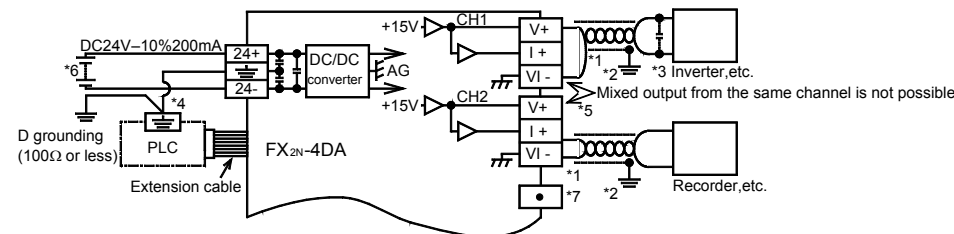

- \*1: Use a twisted pair shielded cable for the analog output. This cable should be wired away from power lines or any other lines which could induce noise.
- \*2: Apply 1-point grounding at the load side of the output cable (grounding: 100Ω or less).
- \*3: If electrical noise or a voltage ripple exists at the output, connect a smoothing capacitor of 0.1 to 0.47μF, 25V.
- \*4: Connect the  $\perp$  terminal on the FX<sub>2N</sub>-4DA with the  $\perp$  terminal on the main unit of the PLC.
- \*5: Shorting the voltage output terminal or connecting the current output load to the voltage output terminal may damage the FX<sub>2N</sub>-4DA.
- \*6: The 24V DC service power of the PLC can also be used.
- \*7: Do not connect any unit to the unused terminal  $\bullet$ .

## 5. SPECIFICATIONS

### 5.1 General specifications

Item	Specification
General specifications	Same as those for the main unit
Dielectric withstand voltage	500V AC, 1min (between all terminals and ground)

### 5.2 Performance specification

Item	Centigrade	Fahrenheit		
Analog output range	-10V DC to +10V DC (External load resistance: 2kΩ to 1MΩ).	DC 0mA to +20mA (External load resistance: 500Ω).		
Digital input	16 bits, binary, with sign (Effective bits for numeric value: 11 bits and sign bit (1 bit))	16 bits, binary, with sign (Effective bits for numeric value: 10 bits)		
Resolution	5mV (10V × 1/2000)	20μA (20mA × 1/1000)		
Total accuracy	±1% (at full scale of +10V)	±1% (at full scale of +20mA)		
Conversion speed	2.1ms for 4 channels (Change in the number of channels used will not change the conversion speed.)			
Isolation	Photo-coupler isolation between analog and digital circuits. DC/DC converter isolation of power from main unit. No isolation between analog channels.			
External power supply	24V DC ±10% 200mA			
Number of occupied I/O points	The analog block occupies 8 I/O points. (can be either inputs or outputs)			
Power consumption	5V, 30mA (Internal power supply from MPU or powered extension unit)			
I/O characteristics (Default: mode 0) Follow the procedure described in section 8 to change	Mode 0 (Voltage output: -10V to +10V)	At load resistance of 10kΩ	Mode 1 (Current output: +4mA to +20mA)	At load resistance of 250Ω
Command sent from the programmable controller can change the mode. The voltage/current output mode selected will determine the output terminals used.		Mode 2 (Current output: 0mA to +20mA)		At load resistance of 250Ω

## 6. ALLOCATION OF BUFFER MEMORIES (BFM)

Data is transmitted between the FX<sub>2N</sub>-4DA and the main unit via buffer memories (16-bit 32-point RAM).

BFM	Description
#0 E	Output mode select. Factory setting H0000
#1	Output data (Signed 16 bits binary: actual value 11 bits + sign) #1: CH1, #2: CH2, #3: CH3, #4: CH4
#2	
#3	
#4	
#5 E	Data holding mode. Factory setting H0000
#6, #7	Reserved

Buffer memories marked "W" can be written to using the T0 instruction in the main unit.

The status of BFM #0, #5, and #21, (marked E) will be written to EEPROM, therefore the set values will be retained even after turning off the power.

- [BFM #0] Output mode select: The value of BFM #0 switches the analog output between voltage and current on each channel. It takes the form of a 4 digit hexadecimal number. The first digit will be the command for channel 1 (CH1), and the second digit for channel 2 (CH2) etc. The numeric values of these four digits respectively represent the following items:



- O = 0: Sets the voltage output mode (-10 V to +10 V).
- O = 1: Sets the current output mode (+4 mA to 20 mA).
- O = 2: Sets the current output mode (0 mA to +20 mA).

Switching the output mode resets the I/O characteristics to the factory-default characteristics. Refer to the performance specifications described in section 4.

- Example: H2110
- CH1 : Voltage output (-10 V to +10 V)
  - CH2 and CH3 : Current output (+4 mA to +20 mA)
  - CH4 : Current output (0 mA to +20 mA)

- [BFM #1, #2, #3 and #4]: Output data channels CH1, CH2, CH3, and CH4  
BFM #1: Output data of CH1 (Initial value: 0) BFM #2: Output data of CH2 (Initial value: 0)  
BFM #3: Output data of CH3 (Initial value: 0) BFM #4: Output data of CH4 (Initial value: 0)

3) [BFM #5]: Data holding mode: While the programmable controller is in the STOP mode, the last output value in the RUN mode will be held. To reset the value to the offset value, write the hexadecimal value in BFM #5 as follows:

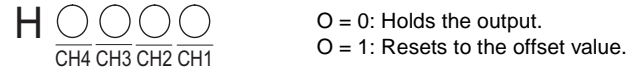

Example: H0011 ..... CH1 and CH2 = Offset value CH3 and CH4 = Output holding

In addition to the above functions, the buffer memories can adjust the I/O characteristics of the FX2N-4DA, and report the status of the FX2N-4DA to the PLC.

BFM	Description
#8	Offset/gain setting command CH1, CH2 Initial value H0000
#9	Offset/gain setting command CH3, CH4 Initial value H0000
#10	Offset data CH1 <sup>*1</sup>
#11	Gain data CH1 <sup>*2</sup>
#12	Offset data CH2 <sup>*1</sup>
#13	Gain data CH2 <sup>*2</sup>
#14	Offset data CH3 <sup>*1</sup>
#15	Gain data CH3 <sup>*2</sup>
#16	Offset data CH4 <sup>*1</sup>
#17	Gain data CH4 <sup>*2</sup>
#18, #19	Reserved
#20	Initialize. initial value = 0
#21 E	I/O characteristics adjustment inhibit (Initial value 1)
#22 - #28	Reserved
#29	Error status
#30	K3020 identification code
#31	Reserved

Buffer memories marked "W" can be written to using the TO instruction in the main unit. The status of BFM #0, #5, and #21, (marked E) will be written to EEPROM, therefore the set values will be retained even after turning off the power.

- \*1: Offset data:  
Actual analog output value when corresponding output data (BFM #1 through #4) is 0
- \*2: Gain data:  
Actual analog output value when corresponding output data (BFM #1 through #4) is +1,000
- \*3: When current output mode 1 (+4 mA to +20 mA) is set, the offset data will be automatically set to +4,000 and the gain data to +20,000. When the current output mode 2 (0 mA to +20 mA) is set, the offset data will be automatically set to 0 and the gain data to +20,000.

[BFM #8 and #9] Offset/gain setting command: Changes offset and gain values of channels CH1 through CH4 by writing 1 to the corresponding Hex digits of BFM #8 or #9. The current values will be valid until this command is output.

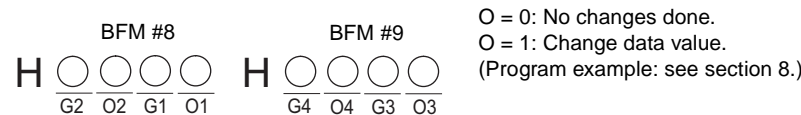

[BFM #10 through to #17] Offset/gain data: The offset and gain values are changed by writing new data to BFM #10 through to #17. The units of the data to be written is mV or μA. The data should be written and then BFM #8 and #9 set. Note that the data value will be rounded down to the nearest 5mV or 20mA.

- [BFM #20] Initialize: When K1 is written in BFM #20, all values will be initialized to the factory-default. (Note that the BFM #20 data will override the BFM #21 data.) This initialize function is convenient if you have an error in adjustment.
- [BFM #21] I/O characteristics adjustment inhibit: Setting BFM #21 to 2 inhibits the user from inadvertent adjustment of I/O characteristics. The adjustment inhibit function, once set, will be valid until the Permit command (BFM #21=1) is set. The initial value is 1 (Permit). The set value will be retained even after power-OFF.
- [BFM #29] Error status: When an error occurs, use the FROM command to read out the details of the error.

Bit	Name	Status when bit is set to "1" (turned on)	Status when bit is set to "0" (turned off)
b0	Error	Error if any of b1 through b4 is turned on	No error
b1	O/G error	Offset/gain data in EEPROM is abnormal or a data setting error occurs.	Offset/Gain data normal
b2	Power supply error	24V DC power failure	Power supplied normally
b3	Hardware error	Defective D/A converter or other hardware	Non-detective hardware
b10	Range error	The digital input or analog output value is out of the specified range.	The input or output value is in the specified range.
b12	G/O-Adjustment prohibit status	BFM #21 is not set to "1".	Adjustable status (BFM #21 = 1)

Bits b4 through to b9, b11, b13 through to b15 are not defined.

4) [BFM #30] The identification code for a special function block is read using the FROM instruction. The identification code for the FX2N-4DA unit is K3020. The main unit can use this facility in the program to identify the special block before commencing any data transfers from and to the special function block.

**Note: BFM #'s marked E.**

- Values of BFM #0, #5, and #21, (marked E) are stored in the EEPROM memory of the FX2N-4DA. BFM #10 to #17 are copied to EEPROM when the gain/offset setting command BFM #8, #9 is used. Also, BFM #20 causes the resetting of the EEPROM memory. The EEPROM has a life of about 10,000 cycles (changes), so do not use programs which frequently change these BFMs.
- A mode change of BFM #0 automatically involves a change of the corresponding offset and gain values. Because of the time needed to write the new values to the internal EEPROM memory, a delay of 3 s is required between instructions changing BFM #0 and instructions writing to the corresponding BFM #10 through BFM #17. Therefore, a delay timer should be used before writing to BFM #10 through #17.

## 7. OPERATION AND PROGRAM EXAMPLES

If the factory-default I/O characteristics are not changed and the status information is not used, you can operate the FX2N-4DA using the following simple program. For the FROM and TO instructions, refer to the FX Programming Manual (II).

CH1 and CH2: Voltage output mode (-10 V to +10 V)  
CH3: Current output mode (+4 mA to +20 mA)  
CH4: Current output mode (0 mA to +20 mA)

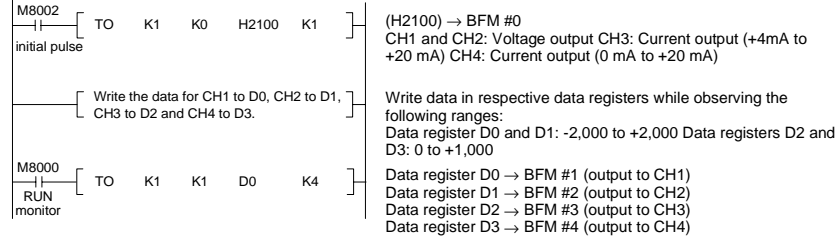

### Operation procedure

- Turn OFF the power of the PLC, and then connect the FX2N-4DA. After that, wire the I/O lines of the FX2N-4DA.
- Set the PLC to STOP, and turn on the power. Write the above program then switch the PLC to RUN.
- Analog values will be sent from D0 (BFM #1), D1 (BFM #2), D2 (BFM #3), and D3 (BFM #4) to the respective output channels of the FX2N-4DA. When the PLC is in STOP, the analog values set before stopping the PLC will remain output. (The output will be held.)
- When the PLC is in STOP, the offset values can also be output. For a detailed description, refer to Section 6, 3).

## 8. CAUTION REGARDING OPERATION

- Check whether the output wiring and/or expansion cables are properly connected on the FX2N-4DA analog special function block.
- Check that the PLC system configuration rules have not been broken, i.e. the number of blocks, and the total system I/O are within the specified range.
- Ensure that the correct output mode has been selected for the application.
- Check that there is no power overload on either the 5V or 24V power source, remember the loading on the main unit or a powered extension unit varies according to the number of extension blocks or special function blocks connected.
- Put the main processing unit into RUN.
- After turning ON or OFF the 24V DC power for analog signals, the analog output may fluctuate for approximately 1 second. This is due to time delays in the power supply from the main unit or differences in start time. For this reason, be sure to take preventive measures so that this output fluctuation will not affect the external units.

### [Example of preventive measure]

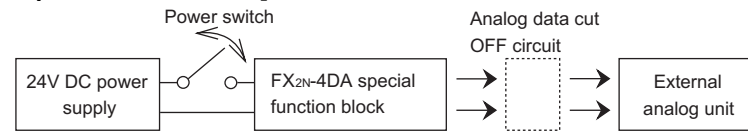

## 9. ADJUSTMENT OF the I/O CHARACTERISTICS

### 9.1 I/O characteristics

The standard characteristics (factory default) are shown by the solid lines in the figure below. These characteristics can be adjusted according to the conditions of the user's system.

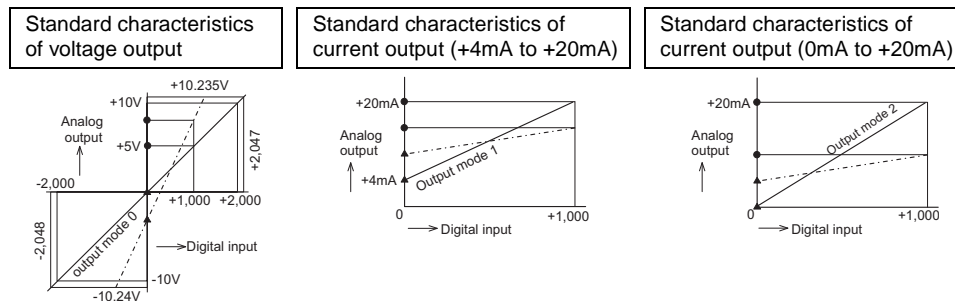

- ... Gain value : Analog output value when the digital input is +1,000
- ▲ ... Offset value : Analog output value when the digital input is 0

Offset and gain can be set independently or together. Reasonable offset ranges are -5V to +5V or -20mA to +20mA, and gainvalue-offset value=1V to 15V or 4mA to 32mA. Gain and offset can be adjusted from software in the main unit.

When the slope of the I/O characteristic line is steep:  
Slight changes to the digital input will greatly increase or reduce the analog output.

When the slope of the I/O characteristic line is gentle:  
Slight changes to the digital input will not always change the analog output.

Note that the resolution (minimum possible change of analog output) of the FX2N-4DA is fixed.

### 9.2 Adjustment of I/O Characteristics

An example program for adjustment is shown below. The example shows that for channel CH2 of FX2N-4DA block No.1, the offset value is changed to 7 mA, and the gain value to 20 mA. Note that for CH1, CH3, and CH4, the standard voltage output characteristics are set.

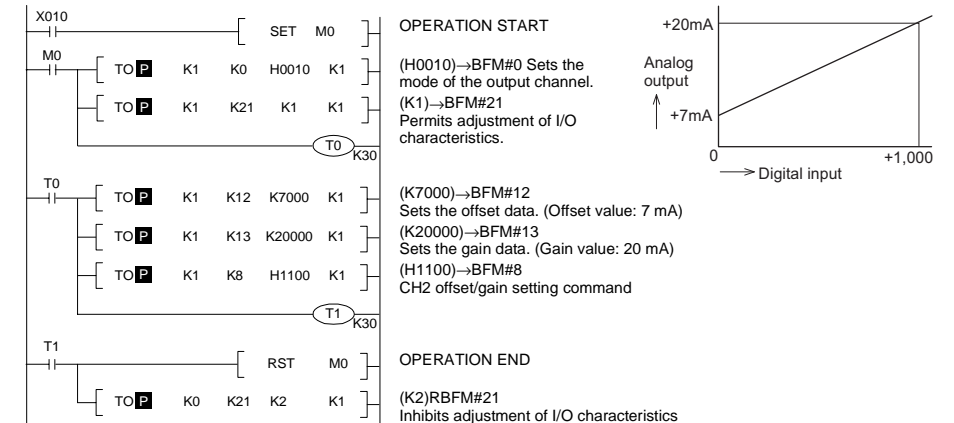

## 10.TROUBLESHOOTING

If the FX2N-4DA does not operate properly, check the following items

- Check the external wiring. Refer to section 4 of this manual.
- Check status of the POWER indicator lamp (LED) of the FX2N-4DA.  
On : The extension cable is properly connected.  
Off or flash : Check connection of extension cable. Also check the 5 V power supply capacity.
- Check status of the 24 V power indicator lamp (LED) of the FX2N-4DA.  
On : 24 VDC is supplied.  
Off : Supply 24 VDC (+10%) to the FX2N-4DA.
- Check the status of the D/A conversion indicator lamp (LED) of the FX2N-4DA.  
Flash : D/A conversion is normal.  
On or off : The ambient conditions are not suitable for the FX2N-4DA, or the FX2N-4DA is defective.
- Check that the external load resistance connected to each analog output terminal does not exceed the capacity of the FX2N-4DA drive (voltage output: 2kΩ to 1 MΩ / current output: 500Ω).
- Check the output voltage or current value using a voltmeter or ammeter, and confirm that the output meets the I/O characteristics. If the output does not meet the I/O characteristics, adjust the offset and gain again. Refer to section 9.

Note

To test the withstand voltage of the FX2N-4DA, connect all the terminals to the grounding terminal.

This manual confers no industrial property rights or any rights of any other kind, nor does it confer any patent licenses. Mitsubishi Electric Corporation cannot be held responsible for any problems involving industrial property rights which may occur as a result of using the contents noted in this manual.

Manual number : JY992D65901

Manual revision : D

Date : September 2007

**MITSUBISHI ELECTRIC CORPORATION**

HEAD OFFICE : TOKYO BUILDING, 2-7-3 MARUNOUCHI, CHIYODA-KU, TOKYO 100-8310, JAPAN  
HIMEJI WORKS : 840, CHIYODA CHO, HIMEJI, JAPAN